



Product Name: CITY OS

General information

- This luminaire must be installed in accordance with the latest edition of the IET Wiring Regulations and local Building Regulation by a qualified competent person.
- The mains power supply must be turned off before inspection, installation or removal of the luminaire, ensuring that the supply is locked off to prevent inadvertently switching the supply on.
- It is the installer's responsibility to ensure that the installation is suitable for the total load of the luminaire(s). The supply cable fuses/circuit breakers must be correctly rated for the electrical load and taking into account for any transient inrush currents that may occur.
- It is the installer's responsibility to ensure that the environmental operating and storage conditions are complied with and that any fire risks are considered.
- Do not perform insulation strength or insulation resistance tests on the installation with the luminaire(s) connected, this can damage the luminaires and give erroneous readings.
- Do not loop-in supply cables at the luminaire supply terminals unless there is provision for 2-way connection at the terminals.
- The light source contained in this luminaire must only be replaced by Tamlite Lighting or an appointed service agent.
- Emergency lighting luminaires must be installed and maintained in accordance with the emergency lighting standard BS 5266-1.
- To ensure that the product warranty remains valid, the luminaire must be installed and maintained in accordance with these installation instructions and the product must not be modified in any way.

-  Luminaires marked with this symbol must not be covered with thermally insulating material.
-  This symbol on covers over light sources indicates dangerous live parts do not operate the luminaire with this cover removed.

Dimensions

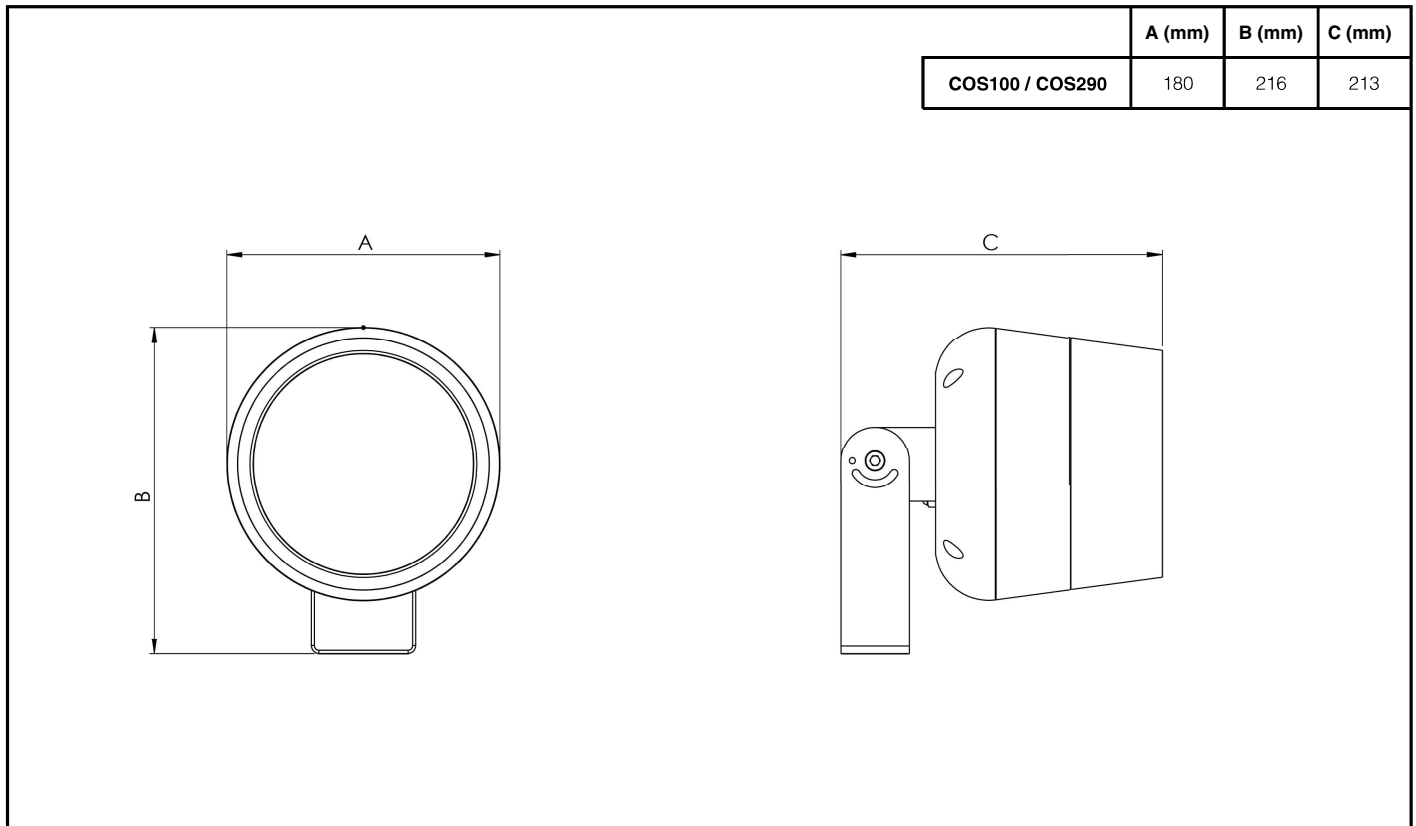



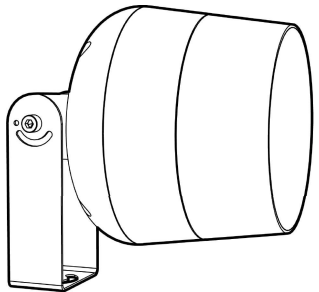
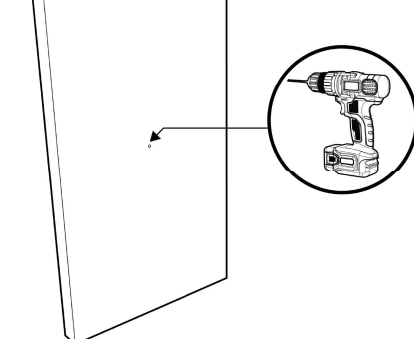
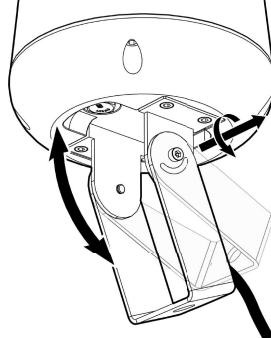
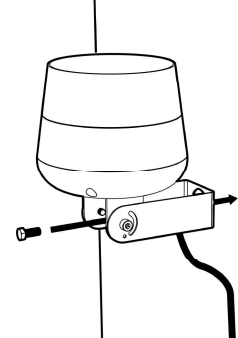
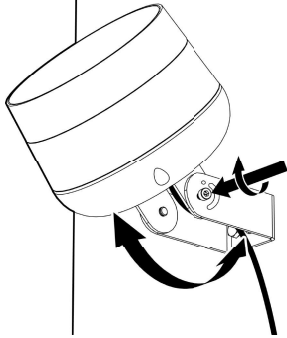
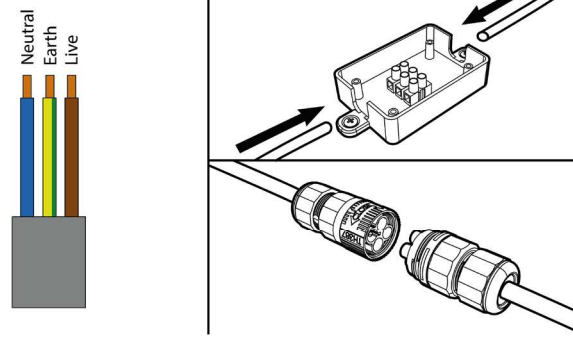
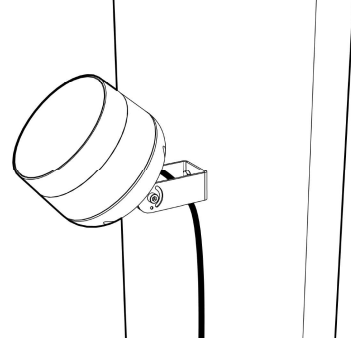

Product Name: CITY OS

<p>1</p>  <p>Remove the product from its packaging.</p>	<p>2</p>  <p>Prepare mounting holes in the desired location.</p>
<p>3</p>  <p>Loosen the bracket bolts and rotate the bracket.</p>	<p>4</p>  <p>Install the bracket using appropriate hardware.</p>
<p>5</p>  <p>Adjust the luminaire to desired angle and tighten the bracket bolts.</p>	<p>6</p>  <p>Connect supply cable to pre-fitted power cord with a suitably rated connector.</p>
<p>7</p> 	

Page 2 of 2

Tamlite Technical
Stafford Park 12,
Telford, Shropshire,
TF3 3BJ

+44(0)1952 292441
technical@tamllite.co.uk
Document No: V1

			200-240V 50/60Hz		IP66	IK08	ta -40°C to 50°C
---	---	---	---------------------	---	------	------	---------------------